



SERVICE MANUAL

PBO1001M

PBO1004M

PBO3004D

PBO6521DM

PBO6524DM

PBO6504M



Contents

Contents	2
Tools:	3
Component Access and Disassembly	4
Door Removal.....	4
Door Installation :	5
Removing the Oven from the Wall.....	5
Door Components	7
Door Handle.....	7
Front Door Glass Assembly.....	7
Control Panel	8
Control Panel Removal.....	9
Oven Controller Removal (In some models).....	9
Components Behind the Back Cover.....	11
Removing the Back Cover	11
Convection Element and Fan.....	12
Convection Baffle Removal.....	12
Convection Element Disassembly	12
Convection Fan Removal.....	13
Convection Baffle Installation	13
Convection Fan (motor).....	13
Bake Element Assembly Removal.....	14
Broil Element Assembly Removal.....	15
Temperature Sensor Removal.....	16
Components Behind the Top Panel.....	17
Cooling Fan (blower).....	17
Electrical Wiring:.....	18
Troubleshoots:.....	22
Error codes:	23

Tools:

Most of the tools that you might need are shown below. Some are optional. The reason for the option is explained.

ELECTRICAL PLIERS or STRIPPERS and Door Removal : For cutting and stripping small electrical wire.

VOM (VOLT-OHM METER): For testing electrical circuits. If you do not have one, please get one. An inexpensive one will suffice, as long as it has both "AC Voltage" and "Resistance" (i.e. Rx1, Rx10) settings on the dial. It will do for our purposes.

BUTT CONNECTORS, CRIMPERS, WIRE NUTS and ELECTRICAL TAPE: For splicing small wire. When splicing wire on ovens, you must make sure you use high-temp connections, such as porcelain wire nuts, high-temp terminals and fiberglass insulated wire.

ALLIGATOR JUMPERS (sometimes called a "CHEATER" or "CHEATER WIRE"): Available at your local electronics store.

SCREW-DRIVERS: Both flat and Phillips head; two or three sizes of each. It's best to have at least a stubby, 4- and 6-inch sizes.

NUT-DRIVERS, WRENCHS: You will need a 1/4 to 1/2 inch size.

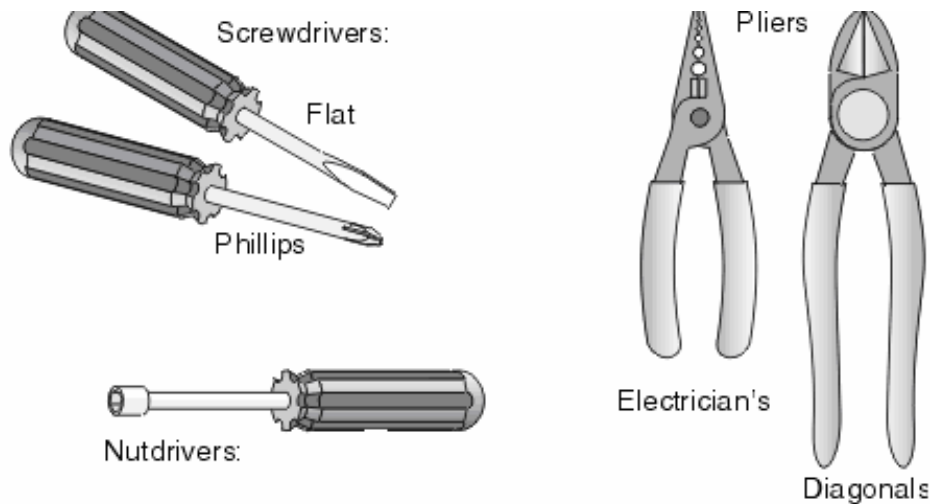

Component Access and Disassembly

WARNING: Turn off the electrical power supply to the appliance prior to servicing it. Failure to disconnect the power supply during service may result in an electrical shock or fire hazard.

Door Removal

WARNING: Do not attempt to disengage the hinge locks on the door while it is removed from the oven.

WARNING: The hinge springs could release, causing personal injury.

WARNING: Do not lift or carry the oven door by the door handle.

- Open the oven door completely.
- Pull the hinge locks forward on both hinges, until they stop.
- Raise the door so that it is at a 15° angle from the front of the oven. Hold the door with one hand on each side. Lift the door up and out.
- See page 7 for door disassembly and repair instructions.

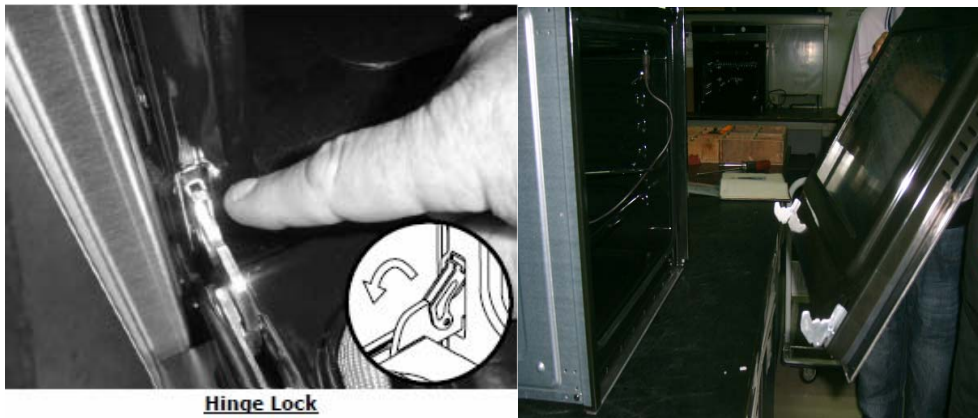

Door Installation :

WARNING: Be sure that the notch on the bottom of each hinge rests on top of the lower lip of EACH hinge receptacle before attempting to open the oven door. Failure to do so may cause the door to fall off its hinges, resulting in personal injury or damage to the door.

WARNING: Rotate the hinge locks toward front of the oven immediately after installation of the door. Failure to do so may cause the door to fall off its hinges, resulting in personal injury or damage to the door.

- Grasp the oven door on opposite sides and hold it at a 15° angle from the front of the oven. Slide the hinges into the hinge openings, resting the bottom of the hinge arms on the lower lip of the hinge receptacles. Continue to hold the door at a 15° angle with one hand while pushing in on the each of the bottom corners of the door. Push until the notch on the bottom of each hinge slips over the lower lip of each hinge receptacle.
- Lower the door to the fully opened position.
- Rotate the two hinge locks toward the oven.
- Open and close the door completely to ensure that it is properly installed.

Removing the Oven from the Wall

WARNING: Use an appliance dolly to move the appliance when installing it or removing it from the wall for service. Use of an appliance dolly will minimize the risk of personal injury as a result of the oven tipping.

WARNING: Hold the oven steady when removing it from the wall. Otherwise, the oven will have a tendency to tip forward, increasing the risk of personal injury.

WARNING: Do not use the door or the door handles to lift, carry, or move the oven. Personal injury may result.

NOTE: Not all service procedures require that the oven be removed from the wall. See the appropriate procedure to determine if removal from the wall is necessary.

- Remove the oven door(s) as described on page 4. Due to the weight of this appliance, removing the door(s) will significantly reduce the lifting load.
- Removing the door(s) will also provide the technician with a place to grip the oven when removing it from the wall.
- Remove the mounting screws that hold the oven in place. The screws are located inside the door jams of oven on the trim posts on both sides of the oven. Remove the oven racks from the oven.
- Pull the oven out of the wall toward you, using the gripping points and side handles. Hold it steady as you pull. Service procedures require that the oven be pulled completely out of the wall.
- To reinstall the oven, see the installation procedure on page 5.

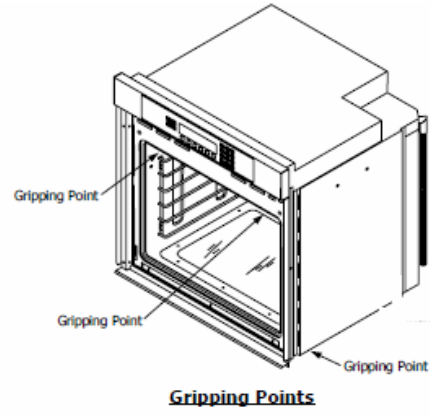

Gripping Points

Door Components

Door Handle

- Remove the oven door(s) as described on page 4.
- Lay the door on a flat, padded surface with the hinges facing up.
- Remove the screws in the bottom edge of the door.
- Grasp the door with one hand and pull up. Pull the door handle out from underneath.
- Remove the screws in the outer glass of the door.
- To reinstall the door handle, grasp the door with one hand and pull up. Hold the handle in position on the front. Lower the door onto the padded surface.
- Replace the screws in the top corners of the door and tighten into place. Do not over-tighten the screws, because the front door glass could crack.
- Reinstall the oven door(s) as described on page 5.



Front Door Glass Assembly

- To prevent personal injury, use gloves in case of handling glass components that are broken or shattered.
- Remove the oven door(s) as described on page 4.
- Lay the door on a flat, padded surface with the hinges facing up.
- Remove the screws in the bottom edge of the door. The outer screws on the bottom of the door are part of the hinge assembly.

- Grasp the top end of the door with one hand and pull up. Pull the door handle out from underneath.
- Holding the door tightly with both hands, turn it over and place it on the flat, padded surface with the front door glass facing up.
- If the door gaskets or hinges require replacement, replace them while the front door glass is removed (depending on the oven models)
- Make sure that the door spacers in the top corners of the door are still in place before putting the front door glass back into in place.
- Holding the door tightly with both hands, turn it over and place it on the flat, padded surface with the door gasket facing up.
- To reinstall the door handle, grasp the top end of the door with one hand and pull up. Hold the handle in position on the front. Lower the door onto the padded surface.
- Replace the screws in the bottom and of the door and tighten into place. Do not over-tighten the screws because the door glass could crack.
- Reinstall the oven door(s) as described on page 5.



Control Panel

WARNING: Turn off the electrical power supply to the appliance prior to servicing it. Failure to disconnect the power supply during service may result in an electrical shock or fire hazard. The control panel, power supply, and relay board assemblies in this oven contain electronic components that are sensitive to electrostatic discharge (ESD). Wear a properly grounded antistatic wrist strap when handling or servicing the printed circuit assemblies. Insert the ESD sensitive circuit boards into antistatic bags before placing them on any surface other than the oven chassis.

Control Panel Removal

- Remove the oven from the wall as specified on page 5.
- Remove the screws from the top of the oven immediately in back the control panel.
- Grab the sides of control panel with both hands and pull it forward with a gentle rocking motion until it comes loose from the front of the oven.
- Disconnect the wires from the back of the control panel printed circuit board assembly.
- When replacing the control panel, connect the wires from the oven to the printed circuit board assembly on the back of the control panel. Match the location marked to on the connectors to the locations marked on the printed circuit board.



Oven Controller Removal (In some models)

- Remove the screws that hold the oven controller in place.
- Remove both of the display flex connectors from the sockets on the back of the oven controller board.
- Pull the oven controller off the back with a gentle rocking motion.
- Remove the display from the back of the board.



To reinstall the control panel:

- Reassemble the control panel in the reverse order.
- Install the control panel in its original position and replace screws that hold it in place.
- Reinstall the oven door(s) as described on page 5.
- Test the oven to ensure that repairs were properly completed.

Components Behind the Back Cover

WARNING: Turn off the electrical power supply to the appliance prior to servicing it. Failure to disconnect the power supply during service may result in an electrical shock or fire hazard.

Removing the Back Cover

- Remove the oven completely from the wall as specified on page 5.
- Remove the screws from the back cover. Some of the screws that hold the cover in place are located around sides.



Convection Element and Fan

WARNING: Turn off the electrical power supply to the appliance prior to servicing it. Failure to disconnect the power supply during service may result in an electrical shock or fire hazard.

Convection Baffle Removal

- Remove the oven door(s) as described on page 4.
- Remove the oven racks from the oven chamber.
- Remove the convection filter by lifting it up and out.
- Remove the screws that hold the convection baffle in place. The screws are located near the four corners of the baffle at the back of the oven.
- Remove the convection baffle.



Convection Element Disassembly

1. To remove convection element, hold it with one hand and turn the nut clockwise with a wrench.
2. Grasp the convection element at the base and pull it out slowly with a gentle, rocking motion. Do not pull the convection element out too quickly because the wires that connect to the element could pull free inside the oven wall.
3. Disconnect the wires from the terminals of the element and remove it from the oven.
4. To replace the convection element:
 - 4.1 Place the convection element in the oven and attach the wires to the terminals.
 - 4.2 Grasp the convection element at the base and push it slowly back into place with a gentle rocking motion.
 - 4.3 Replace the mounting nut that hold the convection element in place.



Convection Fan Removal

- To remove the convection fan, hold it with one hand and turn the nut clockwise with a wrench.
- When replacing the fan, make sure that the washer is installed behind the fan blade before replacing the fan. Use a wrench to tighten the nut counter clockwise.



Convection Fan Nut Removal

Convection Baffle Installation

- Install the convection baffle against the back wall of the oven.
- Replace the mounting screws that hold the baffle in place.
- Reinstall the oven door(s) as described on page ???.
- Test the oven to ensure that repairs were properly completed

Convection Fan (motor)

- Remove the convection fan blade from inside the oven.
- With the convection fan and back cover removed (see page 11), disconnect the power wires connected to the fan motor.
- Remove the screws **D** that hold the convection fan motor in place.

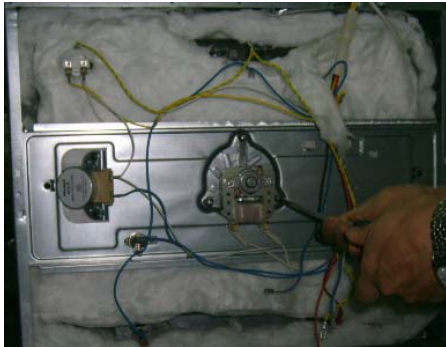

To reinstall the convection fan assembly:

- Place the convection fan against the back wall of the oven with the electrical terminals facing up.
- Attach the fan motor to the back of the oven using the existing screws.
- Attach the fan motor wires to the terminals on the fan motor
- Reinstall the convection fan and reinstall the convection baffle. Be sure that the convection baffle is in the correct orientation.
- Replace the back cover.
- Reinstall the oven door(s) as described on page 5.
- Test the oven to ensure that repairs were properly completed.
- Reinstall the oven.

Bake Element Assembly Removal

IMPORTANT: The bake element wires must be properly labeled so that they can be connected to the same terminal when the element is replaced. If the wires are not properly connected, the oven will not function properly.

IMPORTANT: When removing it from the oven, do not hold the bake element assembly by the wires. Damage to the bake element terminals may result.

- Remove the oven door(s) as described on page 4.
- Remove the back cover.
- Replace the mounting screws that hold the bake element in place.
- If replacing the bake element, pull it up and out of the floor of the oven. Label the wires that connect to the bake element terminals. When reconnecting the wires, make sure that the wires are connected to the proper terminal.
- When reassembling the bake element in the floor of the oven, place the bake element inside the bake element frame and place it over the top of the bake element in the floor of the oven.
- Hold the bake element frame in place with one hand while replacing the existing screws that hold it in place.
- Reinstall the oven door(s) as described on page 5.
- Test the oven to ensure that repairs were properly completed.

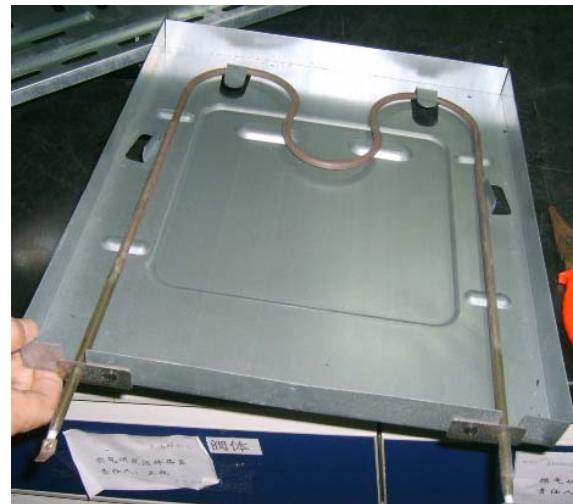

Broil Element Assembly Removal

IMPORTANT: The broil element wires must be properly labeled so that they can be connected to the same terminal when the element is replaced. If the wires are not properly connected, the oven will not function properly.

IMPORTANT: When removing it from the oven, do not hold the broil element assembly by the wires. Damage to the broil element terminals may result.

- Remove the oven door(s) as described on page 4.
- Remove the oven racks from the oven chamber.
- Holding the broil element assembly in place with one hand, remove the screws that hold it in place.
- Gently lower the broil element out of the ceiling of the oven chamber.
- Label the wires that connect to the broil element.
- Gently remove the broil element wires from the terminal block on the broil element assembly.
- To reassemble the broil element assembly, use the existing screws.
- Place the broil element into the oven chamber.
- Lift the back of the element up and reconnect the broil element wires to the terminals on the broil element assembly. Make sure that the wires are connected to the proper terminals.
- Insert the broil element assembly into the hole in the oven ceiling while pushing the broil element wires into the access hole toward the back.
- Hold the broil element assembly in place with one hand while replacing the existing screws that hold it in place.
- Reinstall the oven door(s) as described on page 5.
- Test the oven to ensure that repairs were properly completed.

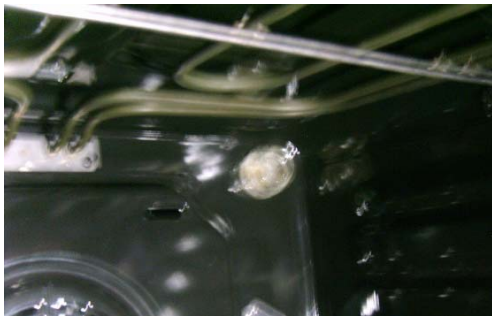

Temperature Sensor Removal

- Remove the oven door(s) as described on page 4.
- Remove the oven racks from the oven chamber.

Rack Support Removal

- Remove the screws that hold the rack support (on the appropriate side) in place. Be careful not to scratch the inside surface of the oven when removing it.

Temperature sensor removal

- Remove the screws that hold the temperature sensor in place.
- When removing the temperature sensor, pull the wires attached to the sensor gently toward you through the hole in the back of the oven to expose the connector. Do not pull hard on the wires because the connector may come loose inside the oven wall. Use a screwdriver, if necessary, to move the insulation around behind the hole to allow the connector to slide out into the oven chamber.
- Disconnect the temperature sensor wires at the connector and remove the temperature sensor.
- When reinstalling the temperature sensor, gently push the connector and excess wire through the access hole and insulation at the back of the oven.
- Tighten the temperature sensor into place with the existing mounting screws.

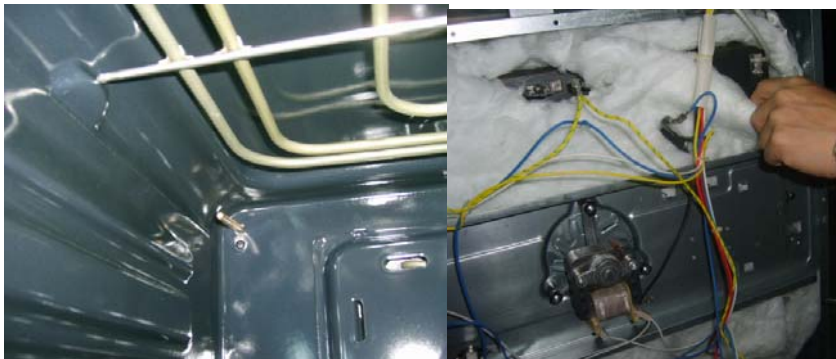

Rack Support Installation

WARNING: To prevent scratching of the oven and wall, replace the rack support only in the manner specified below.

- Insert the end of the rack support with the two vertical bars first. Insert the rack support into the oven at a 45° angle to the sidewall, placing the two vertical bars behind the temperature sensor.
- Rotate the rack support into place, matching the four protruding pins on the rack support to the holes in the oven wall.
- Mount the rack support in place using the existing screws.
- Reinstall the oven door(s) as described on page 5.
- Test the oven to ensure that repairs were properly completed.

Components Behind the Top Panel

Cooling Fan (blower)

WARNING: Accessing the cooling fan requires that oven's top panel be removed. When the top panel is removed, the oven's printed circuit assemblies are exposed. The printed circuit assemblies contain electronic components that are sensitive to electrostatic discharge or ESD. Wear a properly grounded antistatic wrist strap when touching or servicing the printed circuit assemblies.

- Remove the top panel by removing the screws that hold it in place.
- Remove the screws at the base of the blower. Remove the cooling fan assembly.

To reinstall the cooling fan assembly:

- Inspect the fan first. The fan blades must be straight and not dented, so that there is no vibration when spinning.
- Line up the screw holes on the blower with the mounting holes in the exhaust ducts that hold the cooling fan assembly in place. Insert the existing screws into the holes and tighten into place.
- Connect the power wires to the terminals on the cooling fan.
- Replace top cover.
- Reinstall the oven door(s) as described on page 5.
- Test the oven to ensure that repairs were properly completed.

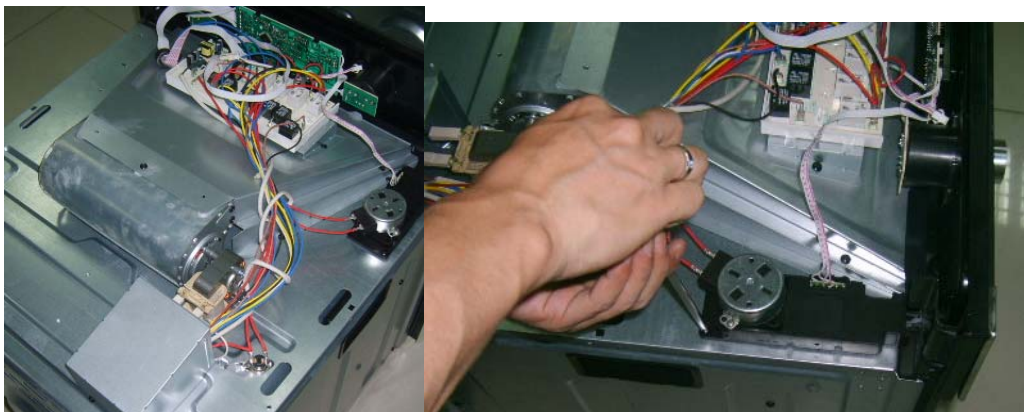

Electrical Wiring:

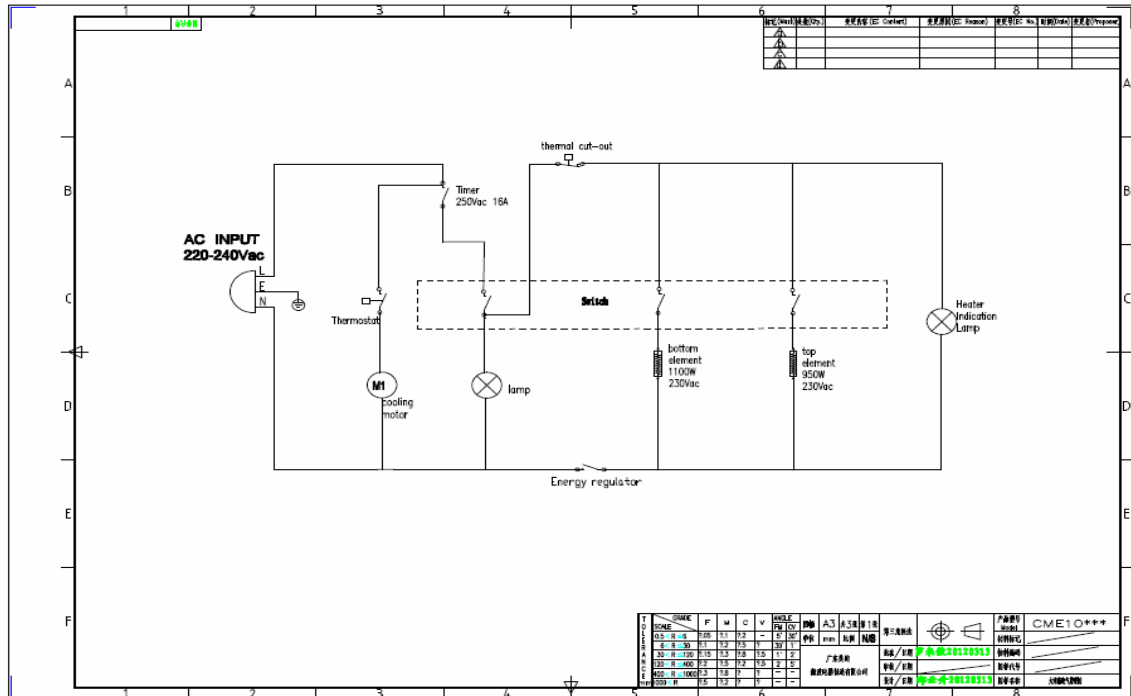

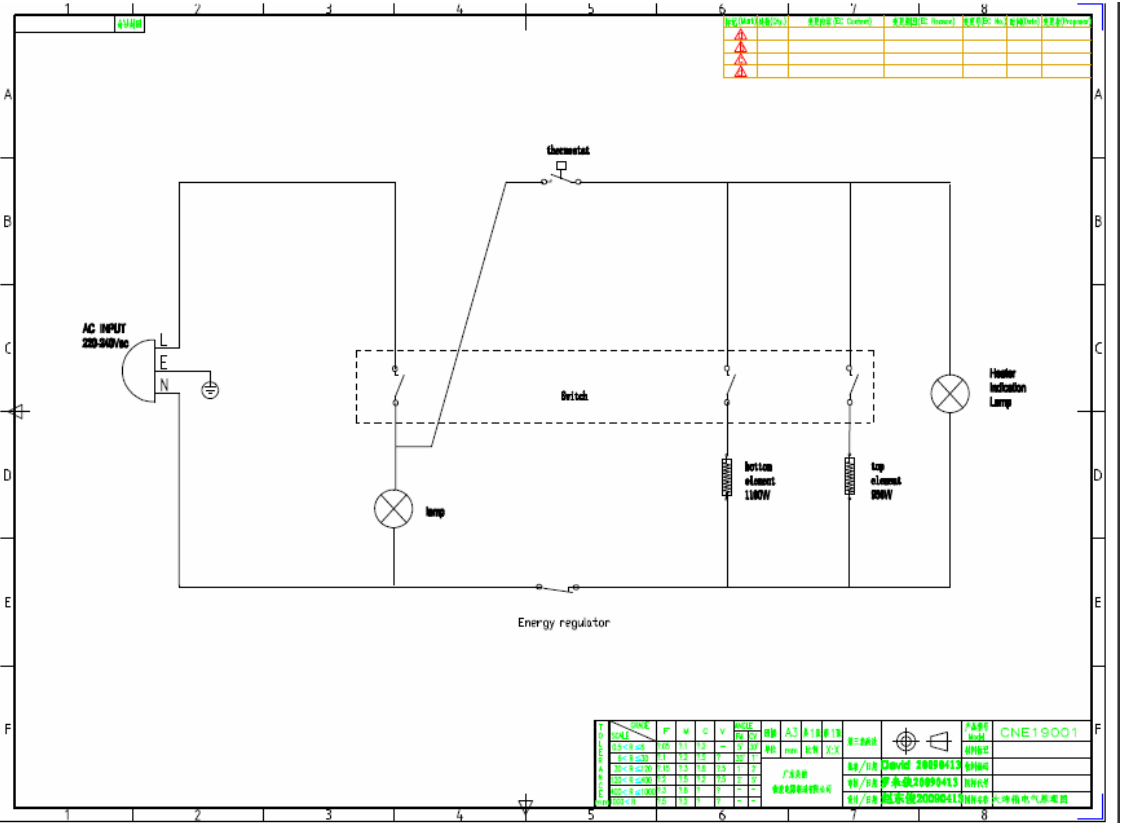
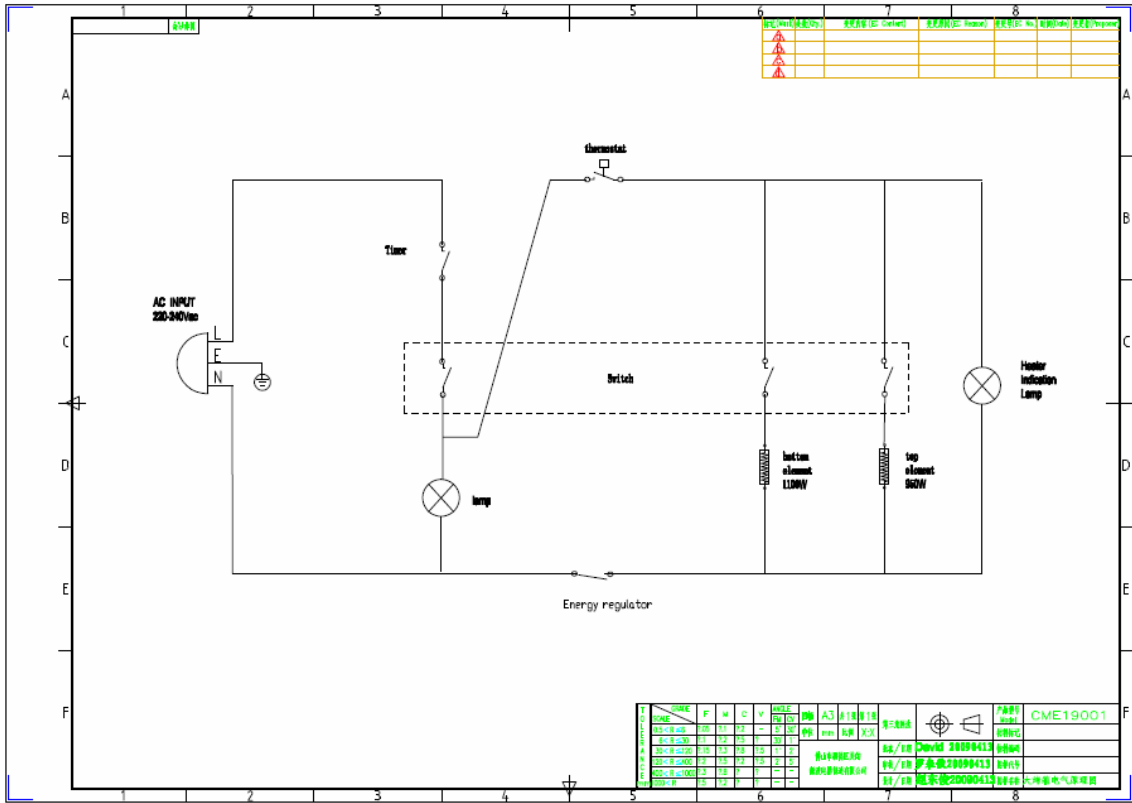

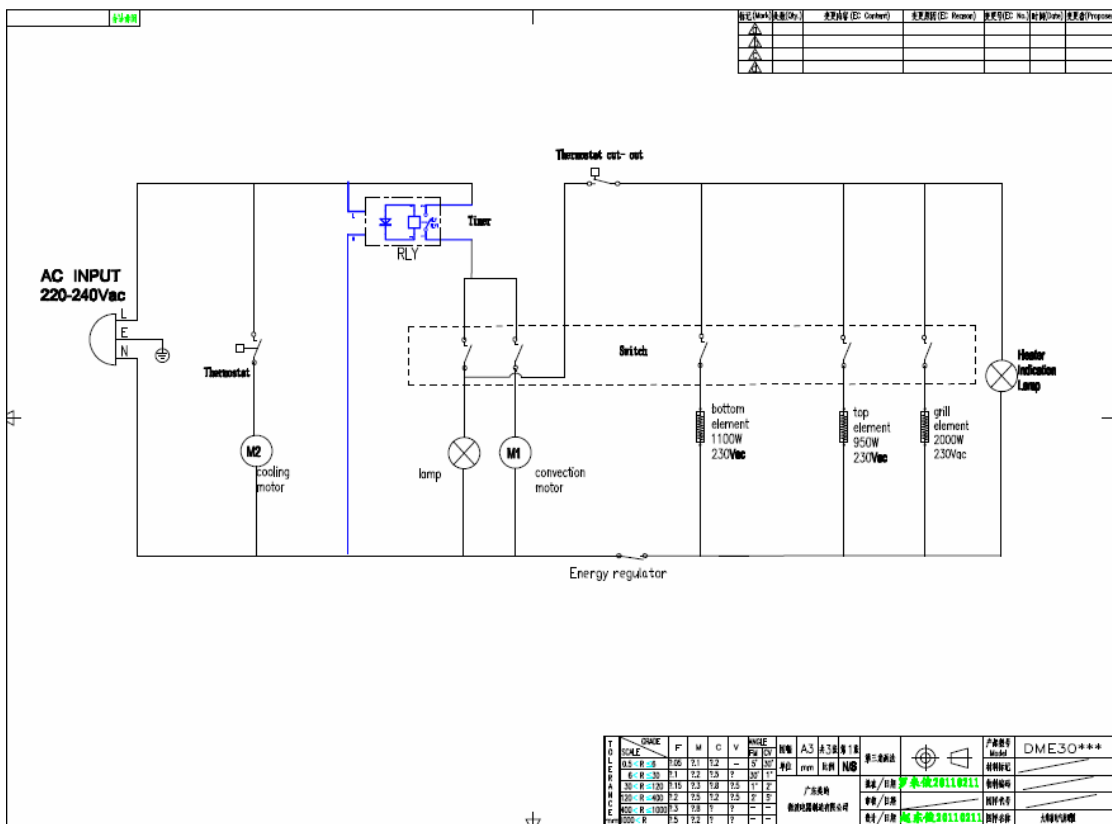
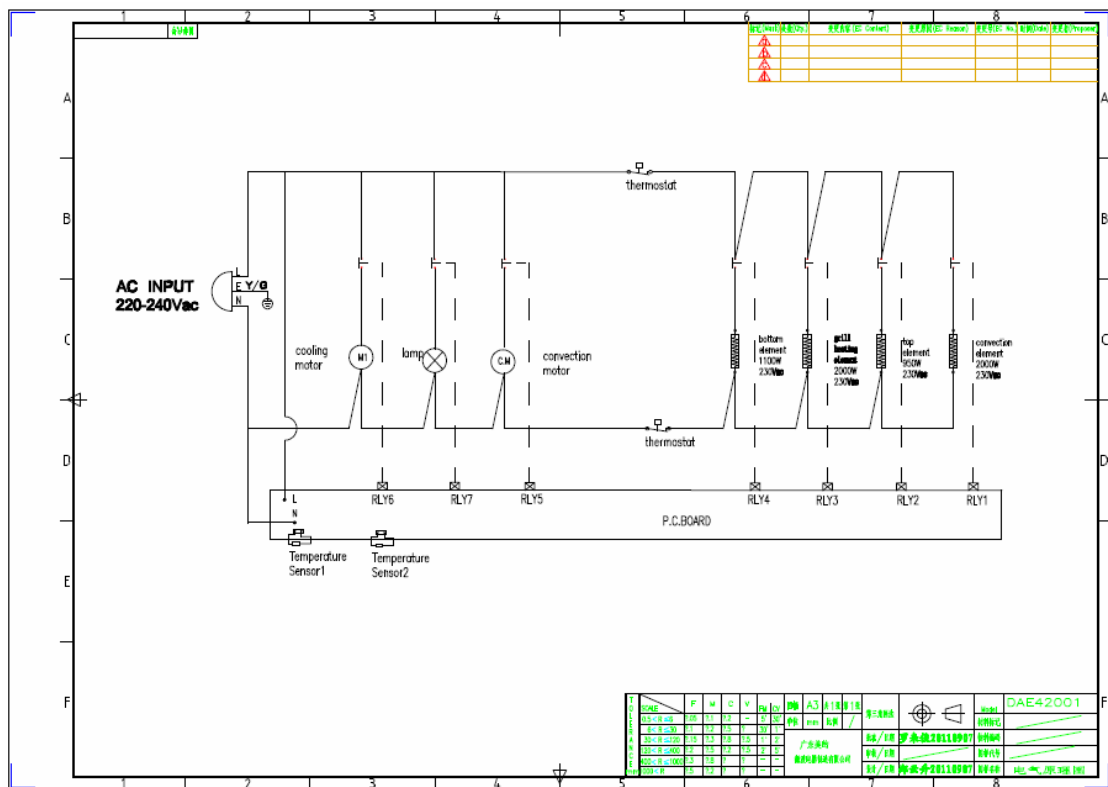

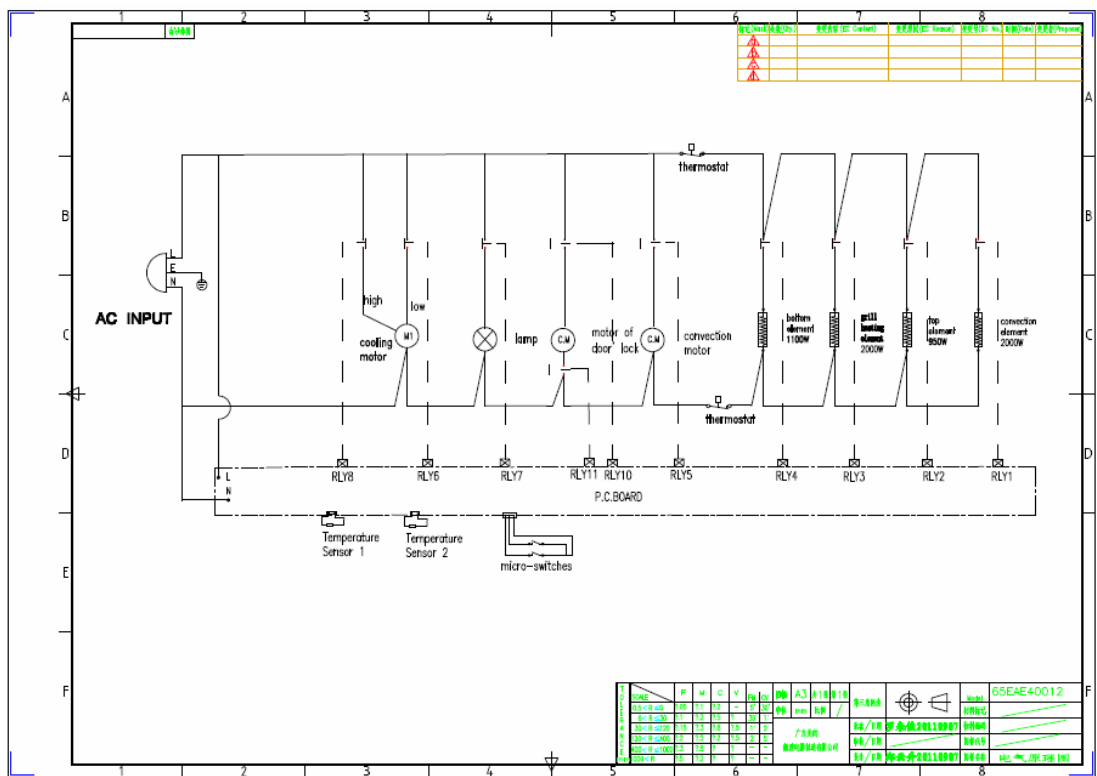
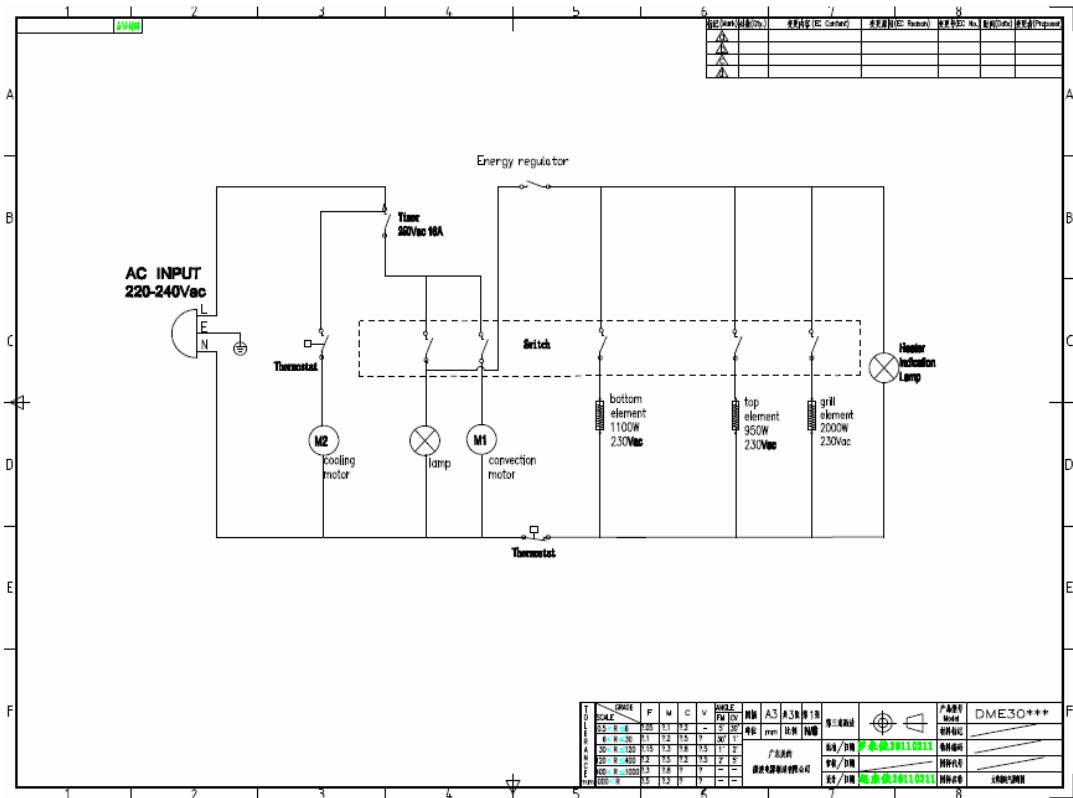

Troubleshoots:

OPERATIONAL DIFFICULTIES AND POSSIBLE CAUSES				
Symptom	Cause or Source	Troubleshooting Checks	Solution	User Actions/ Solutions
Oven will not heat.	Oven set for delay timed cooking.	Oven will turn on automatically at preset time. Press CANCEL/SECURE to return to normal operation.	Oven will turn on automatically at preset time. Press CANCEL/SECURE to return to normal operation.	Oven will turn on automatically at preset time. Press CANCEL/SECURE to return to normal operation.
	Open heating element	Check elements at harness connection point.	Replace elements or if needed replace harness.	Call for service.
	Broil elements and convection fan will turn off if oven door is open.	Verify door is closed.	Verify door is closed.	Verify door is closed.
	Door switch is operating incorrectly and oven is in BROIL mode.	Check oven by simulating door closed by placing a magnet against the door switch	If BROIL element does not turn on, replace switch in oven frame only.	Call for service.
No time is displayed or the time is incorrect.	Time of day not set.	Set clock.	Set clock.	See set clock in use and care manual.
Oven does not self-clean	Door not shut tight ("closeoven door" message displayed).	Check for obstructions. Close door tightly.	Check for obstructions. Close door tightly.	Check for obstructions. Close door tightly.
	Error code displayed.	Correct source of error and clear error codes.	Correct source of error and clear error codes.	Correct source of error and clear error codes.
	Oven set for delay timed cleaning.	Oven will start to self-clean at preset time. Press CANCEL/SECURE to return to normal operation.	Oven will start to self-clean at preset time. Press CANCEL/SECURE to return to normal operation.	Oven will start to self-clean at preset time. Press CANCEL/SECURE to return to normal operation.
Oven lights will not work.	Oven is in the SELF CLEAN cycle.	Wait for completion of self clean cycle.	Wait for completion of self clean cycle.	Wait for completion of self clean cycle.
	Light bulb(s) burned out.	Replace light bulb(s).	Replace Light bulb(s).	Replace light bulb(s).
Door will not open.	Oven is in SELF CLEAN or self-clean cycle has ended and oven is cooling.	Check display. 1) If display indicates SELF CLEAN, wait for display to indicate Door Unlocked to open door.2) Check display for DOOR LOCKED OVEN COOLING.	Check display. 1) If display indicates SELF CLEAN, wait for display to indicate Door Unlocked to open door.2) Check display for DOOR LOCKED OVEN COOLING.	Check display. 1) If display indicates SELF CLEAN, wait for display to indicate Door Unlocked to open door.2) Check display for DOOR LOCKED OVEN COOLING.
Cooling fan will not turn off.				
Outer Door Glass Broken.	Shipping damage.	Check packaging condition	Replace door glass assembly.	Call for service.
Inner Door Glass Broken.	Shipping damage.	Question for incident details.	Replace window pack.	Call for service.
	Cold item placed on hot glass.	Question for incident details.	Replace window pack.	Call for service.
	Item dropped on window pack.	Question for incident details.	Replace window pack.	Call for service.
Food is burnt or oven bakes uneven.	Food placed in oven during pre-heat	Check time food is inserted into oven.	Educate customer to not put food into oven during preheat except for PURE CONVECTION SEAR.	Verify food is not in oven during Pre-heat
	Use of BROIL mode	Check cooking mode.	Educate customer to verify cooking mode.	Verify cooking mode
	Food may be too close to the heating elements.	Check rack position	Educate the customer on rack positions and use of manuals	use and care manual will provide tips on best rack positions to use
	Temperature setting too high for recipe or quantity of food.	Check temperature setting. Verify temperature setting against recipe.	Educate customer on setting temperature	Check temperature setting. Verify temperature setting against recipe.

Error codes:

Displayed Error Message	Description / Failure Criteria	Software Logic Description	Solution
Er-1	Temperature sensor open circuit	all load stopped working	(1) Turn off the power, 1 minute later, turn on the power, checked whether display error code or not. (2) Turn off the power, open the oven to check whether the wire connection is good or not, and reconnect them well. (3) Change the sensor or PCB display board.
Er-2	Temperature sensor short circuit	all load stopped working	
Er-3	Meat probe short circuit	all load stopped working	
Er-4	Oven center temperature is higher than 300 C degree	Cooking mode canceled and return to standby mode, the door lock activated, cooling fan working in high speed, then cooling fan change to low speed and stopped.	(1) Press the CANCEL button to see whether display error code or not. (2) Close the oven door, wait about 10 minutes to cool down oven center temperature, and then press the CANCEL button.
Er-5	While in Pyrolytic mode, 10 minutes after oven center temperature reached 200°C, if the temperature is still lower than 270°C, then return to standby mode with Er-5 displayed.		
Er-6	While in Pyrolytic mode, within 2 minutes, the relay for the door lock will started and door will be locked, after the door is locked, the relay will be off. If the door lock still haven't been locked in case oven center temperature is higher than 300°C, all the heating element will be stopped, the relay will stop working.		

